

# Operation Manual

Version 1.0

## FlexA-200HT Microplate Reader



**ALLSHENG**

Hangzhou Allsheng Instruments Co.Ltd.

### Version modification Record:

Version No.	Date	Modification Description
V1.0	2022.04.25	➤ Initial Release

# Foreword

Thank you for purchasing our Microplate Reader. This user manual describes how the instrument works and the operation guide, please read carefully before operation and keep for future reference.

## Opening check

Please check the instruments as well as all accessories with packing list when you first open it. If you find any wrong or missing, please contact distributor or manufacturer.

**HANGZHOU ALLSHENG INSTRUMENTS CO., LTD.**

**Add: Building 1 & 2, Zheheng Science Park, Zhuantang Town, Xihu District, Hangzhou,  
Zhejiang 310024, China**

**Tel.: 0086-0571-89948289**

**Fax: 0086-0571-87205673**

**Website: [www.allsheng.com](http://www.allsheng.com)**

**E-mail: [info@allsheng.com](mailto:info@allsheng.com)**

**File No.: AS221SM**

**Version No.: V1.0, April 2022**

# Safety Warning and Guidelines

## 1. Important information for safe use

Users should have a clear main idea on how to use this instrument before operate, do read this user manual carefully.



Any improper operation without reading manual is forbidden, otherwise there will be risks in cause accidental injury or electrical shock.

Do read manual carefully and operate safely according to this guidelines.



**This instrument intended to use in Scientific Research Only!**

## 2. Safety Tips

The operation, maintenance and repair of the Instrument should comply with the basic guidelines and the remarked warning below. If you don't comply with them, it will have effect on the scheduled using life of the Instrument and the protection provided.



The instrument is normal indoor instrument which conforms to class I of GB 4793. 1 standard.



Warning: Biological contamination!! All samples for test, quality control, calibration are regarded as infectious, and any part contact with samples will also need to be treated as infectious. Please wear gloves when operate this device.



Before using the device, read the Manual carefully. These units are designed for use in laboratory environments. The device must be used by skilled personnel with the appropriate training.



Warning: Avoid injury. Keep your body or any part of body away 15cm (or more) from the instrument when running.



Operator should not open or repair the instrument without vendor's authorization, or there might be potential damages or injuries and also will affect the warranty. If there is some wrong with the Instrument, please contact manufacturer for repair.

Before connecting to power, make sure the voltage used is same as the instrument required, and the maximum rated load should be sufficient for the instrument.



Please replace the power cord with same specs if the power cord is damaged. Please make sure there's nothing covered the power cord and keep it away from crowds when in use.

Insert and pull the plug with hand gently and make sure the plug completely insert to the socket.



The Instrument should be put in the place of low temperature, less dust, no water and no sun or strong lamp. What's more, the place should be good ventilation, no corrosively gas or strong disturbing magnetic field, far away from central heating, camp stove and other hot resource.



Power off when you finish your work. Pull off the connector plug when there's long time no use of the Instrument and cover it with a cloth or plastic paper to prevent from dust.

Pull the connector plug from the socket at once in the following cases, and contact the vendor:



- There is some liquid flowing into the Instrument;
- Drenched or fire burned;
- Abnormal operation: such as abnormal sound or smell;
- Instrument dropping or outer shell damaged;
- Malfunction.

### **3. Post-sale service**

#### **a) Warranty Content**

Within one month from the date of delivery, the company will guarantee the replacement of the instrument for defects in materials and manufacturing.

This instrument is guaranteed for failure caused by material and manufacturing defects within 12 months from the date of delivery. During the warranty period, our company will selectively repair or replace the instrument which is proved to be defective.

The guaranteed products should be sent by the user to the maintenance department designated by the company. The users should pay for the freight of deliver the equipment to the company and we will pay for the freight of deliver back.

We will charge the cost of repairing if the equipment is out of warranty period.

#### **b) Warranty Coverage**

The above warranty is not applicable to the damage caused by improper use and maintenance of the user, the user under non-conforming conditions, unauthorized maintenance or modification.

# Contents

Foreword .....	I
Opening check .....	I
Safety Warning and Guidelines .....	II
Chapter 1 Brief Introduction .....	1
Chapter 2 Features .....	2
Chapter 3 Instrument Structure .....	3
Chapter 4 Installation .....	4
1. Opening check .....	4
2. Installation .....	4
3. Installation steps .....	4
Chapter 5 Operation Guide .....	6
1. Instrument self-check .....	6
2. System settings .....	8
3. Protocol Management .....	8
4. Read a Microplate .....	11
5. Result processing .....	16
6. Report exporting .....	24
7. Power off .....	24
Chapter 6 Cuvette function description .....	25
1. Interface function .....	25
2. Abs-Endpoint .....	25
3. Abs-Spectrum .....	27
4. Abs-Kinetic .....	30
5. Standard Curve—Curve .....	32
6. Standard Curve—Test .....	34
Chapter 7 Maintenance, storage, transportation .....	35
1. Maintenance .....	35
2. Storage and transportation .....	35
Chapter 8 Trouble shooting .....	36

## Chapter 1 Brief Introduction

This automatic microplate reader FlexA-200HT is professional instrument for ELISA, measuring concentration, absorbance, positive or negative of the antibody and antigen in the sample by testing the color of the Enzyme - Linked Immunosorbent Assay (ELISA). This reader is widely used in clinical test, biology agriculture, food and environment research, especially benefit from ELISA kits increasingly wide utilization.

### Highlights:

- 1) With 10-inch touch screen.
- 2) Operating system allows acquisition, editing and saving of data.
- 3) It can be used alone, and also connect with PC by ReaderIt-II software for plenty of data analysis.
- 4) 96-well visual layout allows easy setting of blank, sample, positive/negative, quality control and multi-value comparison.
- 5) With dual optical system, as well as reference optical channel which guarantee stable detection data.
- 6) End point method, kinetics and spectral scanning are available, as well as plates with or without lids.
- 7) Xenon lamp with long lifetime which can reach to  $10^9$  times.
- 8) With incubation function, the average temperature deviation between wells  $\leq 0.5^\circ\text{C}$ .
- 9) Self-checking optical path, top reading and mechanical motion.
- 10) With shaking function, time and speed are adjustable.
- 11) With a cuvette detect function, cuvette can be incubated.
- 12) It supports USB data export, fast and easy to operate.
- 13) System multi-user hierarchical operation, easy for data management.



## Chapter 2 Features

### Working conditions:

Ambient temperature: 10°C~40°C

The relative humidity: 30%~80%(No condensation)

Power: AC100-240V 50-60Hz 2A

### Parameters:

Model Parameter	FlexA-200HT	
Light source	Xenon flash lamp >10 <sup>9</sup> flashes	
Wavelength	200~1000nm	
Bandwidth	<2.5nm	
Wavelength accuracy	2nm	
Wavelength repeatability	0.2nm	
Read-out range	0-4.0 Abs	
Function	Micro plate	Cuvette
Linearity@450nm	R <sup>2</sup> ≥ 0.999, [0.0 - 3.0Abs]	/
Accuracy@450nm	± (1.0% + 0.003 Abs), (0 - 2.0 Abs] ± 2.0%, (2.0 - 2.5 Abs]	± (1.0% + 0.003 Abs), (0 - 2.0 Abs] ± 2.0%, (2.0 - 2.5 Abs]
Precision@450nm	CV < 0.5% or SD < 0.003 (Precision mode); CV < 1.0% (Fast mode)	CV < 0.5%
Stability@450nm	< 0.005 Abs, (0.0 - 2.0 Abs] < 2%, (2.0 - 2.5 Abs]	< 0.005 Abs, (0.0 - 2.0 Abs] < 2%, (2.0 - 2.5 Abs]
Measurement speed	96-well plate: < 8 seconds at Fast mode < 28 seconds at Precision mode	/
Plate shaking	Linear	/
Incubation range	RT+4°C to 45°C	
Temp. accuracy	±0.5°C @ 37°C	
Temp. uniformity	±0.5°C @ 37°C	/
Connections	1 B-type of USB port for PC, 1 Ethernet port, 2 A-type of USB ports	
Power	DC24V 6.67A 160W	
Dimension (W×D×H)	300×500×260mm	
Weight (kg)	15.5kg	

## Chapter 3 Instrument Structure

### Structure

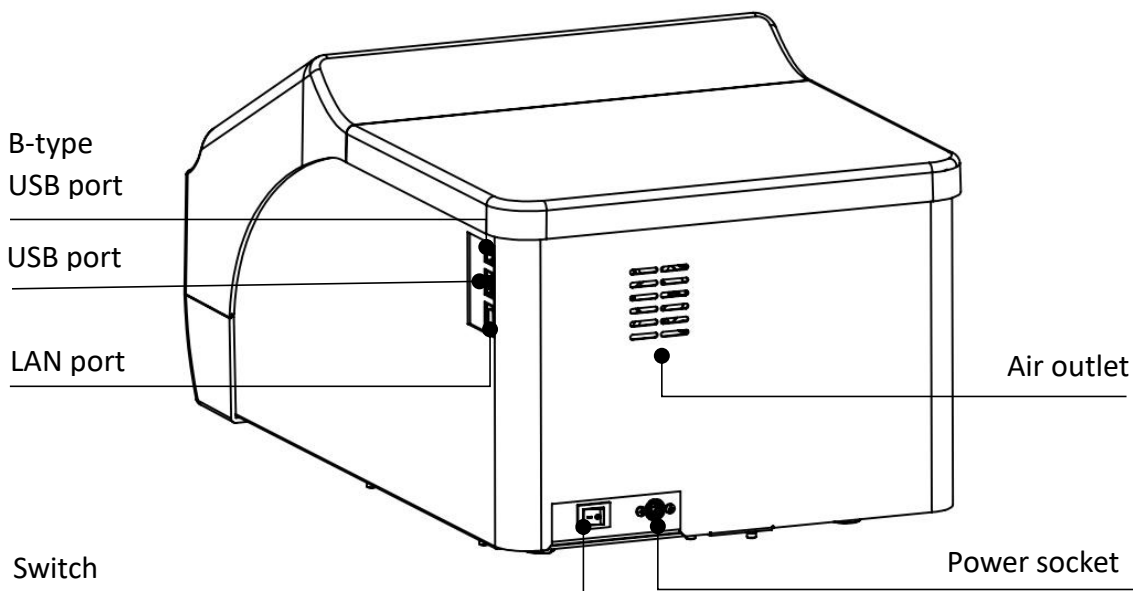
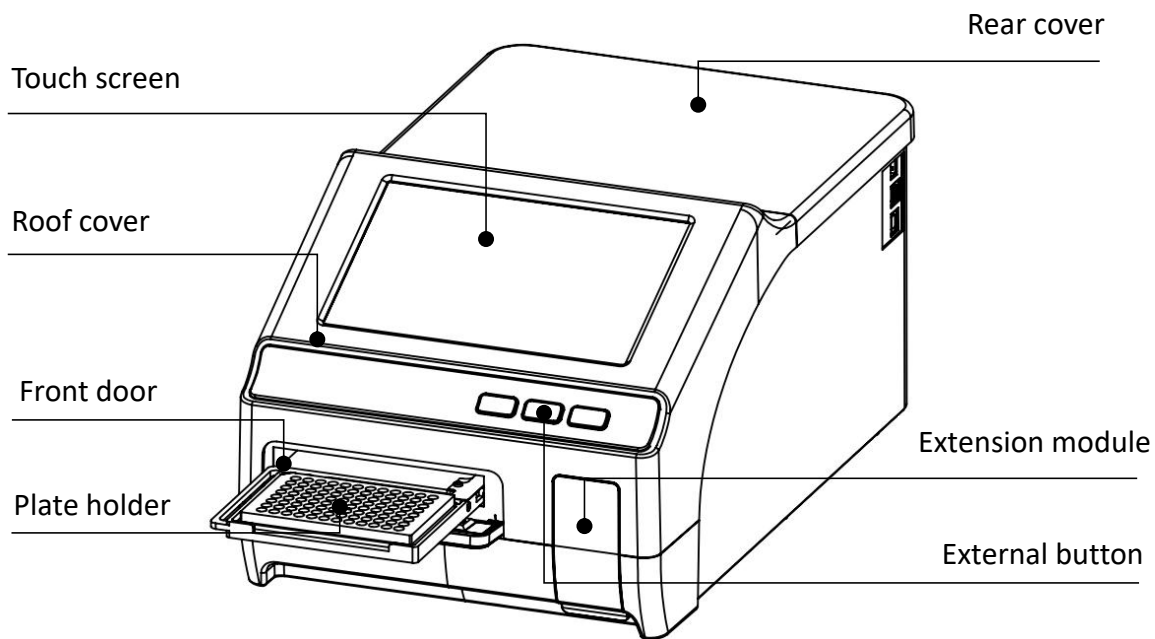

## Chapter 4 Installation

### 1. Opening check

Each FlexA-200HT is thoroughly tested before shipping, but please check again when you receive the instrument and contact your local distributor or manufacturer if:

- The outer package is damaged
- The outer package has any obvious moisture stains
- The outer package has marks of impact
- The outer package has signs of being opened

**After opening, please check the instrument and box contents.**

Confirm that all ordered accessories have been included.

Check the instrument's appearance for any damage.

### 2. Installation

- Working condition: Locate instrument on a flat dry and clean work table, keep the front side with enough space for plate holder in and out, also keeping 15cm space for back, left and right side to enable put or connect wires.
- Working environment:
  - a. Clean air free from corrosion steam or smoke.
  - b. Temperature should be within the range of +10°C ~ +40°C.
  - c. Relative humidity should be within the range of 30% ~ 80% to avoid condensation.

**Note: KEEP INSTRUMENT AWAY FROM DESTRUCTIVE GAS OR LIQUID!**

### 3. Installation steps

- ① Place the instrument on a stable and level surface.

**Note: Please DO NOT loose any screw or parts without permission, or it will cause instrument damage and make it out of warranty.**

- ② Connect the instrument to an appropriate power outlet using the provided power cord.

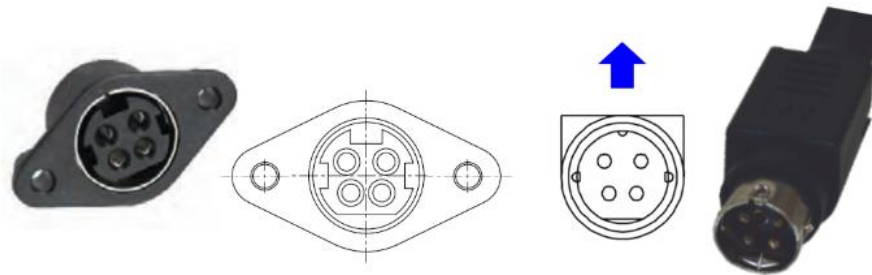

Fig 1

**Note: Attention to the interface of the power adapter, please connect it to the power according to the direction of the above picture.**

- ③ Switch “I/O” button to “I” to turn on the instrument, the front panel will cycle through a start-up and self-test screen.

**Warning: Don't connect instrument to power socket without ground wire.**

## Chapter 5 Operation Guide

### 1. Instrument self-check

This chapter introduces default protocol operation, beginning with self-check after power on. Refer to the picture below:

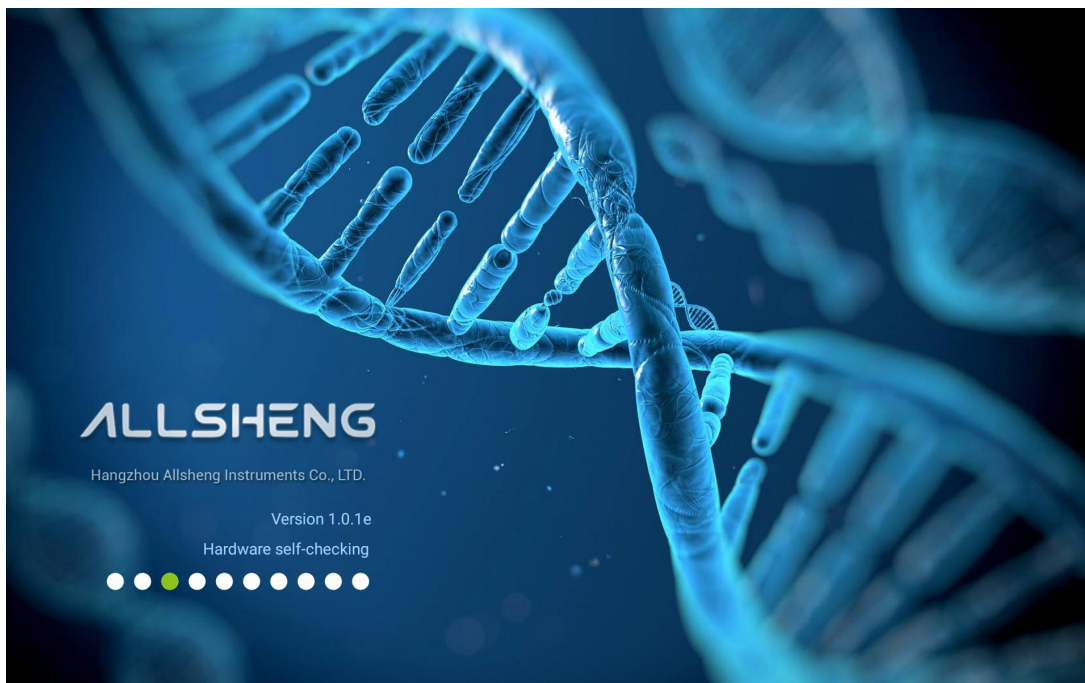

Fig 2

User login interface will appear after self-checking, see Fig 3.

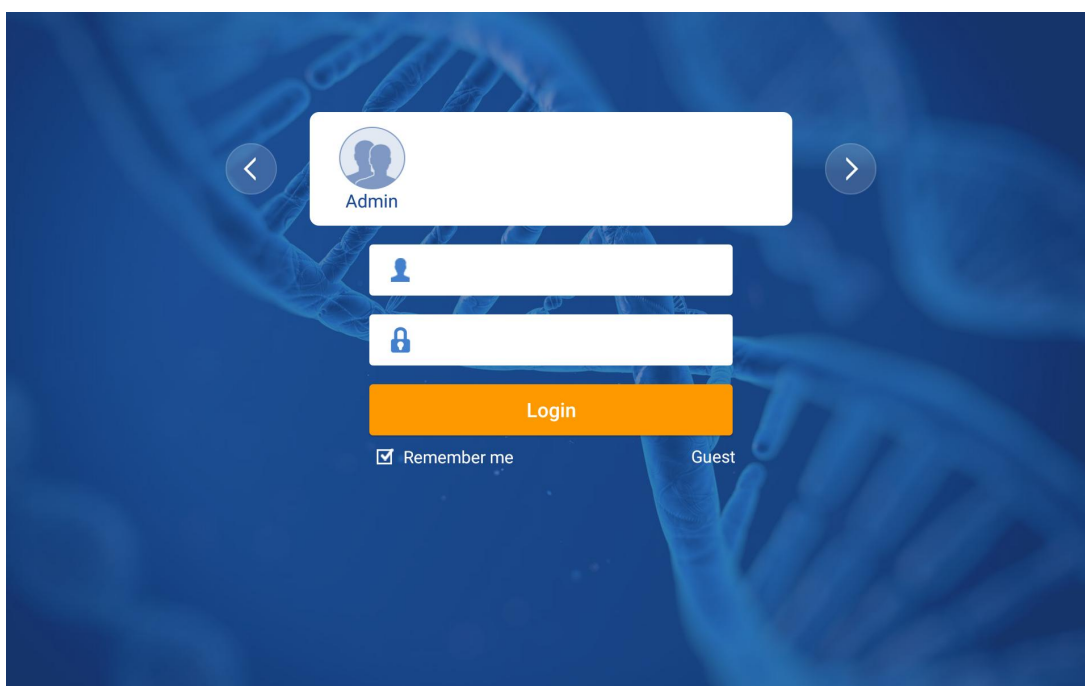

Fig 3

Three types of user permissions, as shown in table 1.

**Table 1**

User type	Creation Method	Default password	Permission	Export
Admin	Can not be deleted	"123456"	For all files of Admin, User and Guest	All can be exported
User	Created by Admin	Default is "123456" or set when creating	Only for their own files	
Guest	Can not be deleted	No password		

**Note: Please keep the Admin password, or contact the manufacturer or your distributor when forgotten the password of Admin.**

Home interface as below Fig 4.

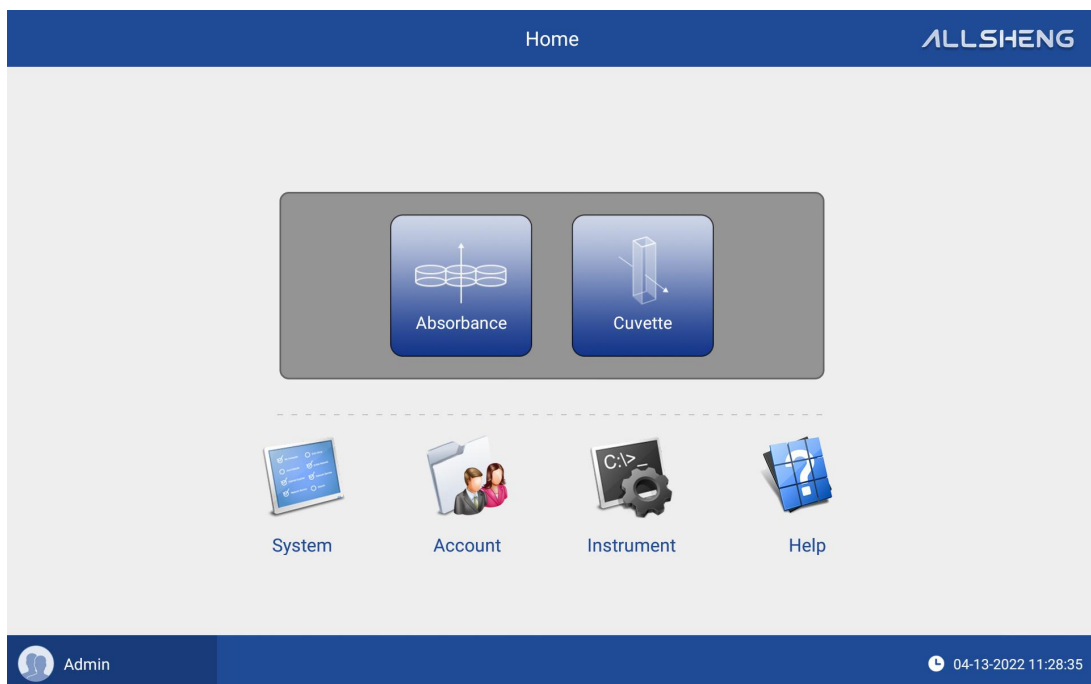

Fig 4

The "Admin" button on the lower left is for logout to login interface.

## 2. System settings

Users can make system settings according to their needs, details see Fig 5.

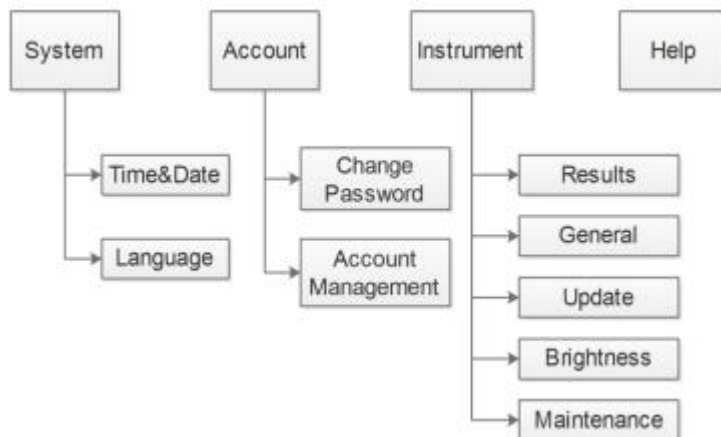

Fig 5

**Note: 1. The instrument need to be restarted after date and time settings finished.**

**2. The function of maintenance is only for manufacturer use, does not open for users.**

**3. Click “Home” button on top left corner for the main interface.**

## 3. Protocol Management

Click “Absorbance” to Fig 6 interface. This interface mainly composed by six parts: the navigation bar at the top, the sidebar, the main display area, the optional bar, switching bar/type select area and the status bar at the lower right area.

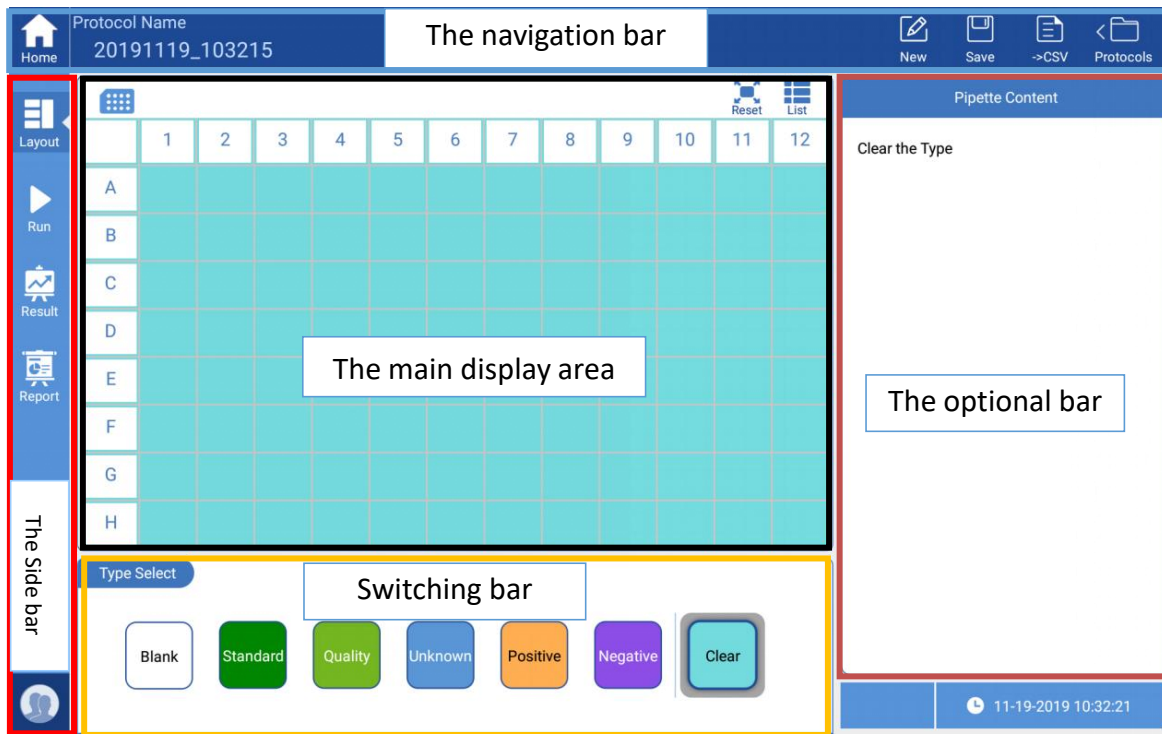

Fig 6



Protocol name can be modified by clicking it directly.



The default name of a new protocol is the system time, and it can be modified by manual. A hint will pop-up when a modified protocol not saved.



Save is for the current protocol saving which can be found in protocol list.



A shortcut for exporting raw data to U disk in format of csv.

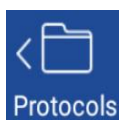

Including sorting, delete, import, export, rename and save as etc. Protocol list will be appear if clicking “Protocols” button, see Fig 7, click blank area will close the protocol list interface.



Account		Admin		Edit
Search				
	Name	Date	State	
1	demo1	2009/08/31 13:01:19	Locked	
2	demo2	2009/08/31 13:01:20	Locked	
3	demo3	2009/08/31 13:01:21	Locked	
4	20191115_163209	2019/11/15 16:32:47	Executed	
5	20191115_163153	2019/11/15 16:32:01	Executed	
6	20191115_153811	2019/11/15 15:39:25	Executed	
7	20090831_131608	2019/11/15 15:38:11	Executed	
Total : 13 Protocols				
Import		Rename		SaveAs

		Admin		Cancel
<input type="checkbox"/>	Name	Date	State	
	demo1	2009/08/31 13:01:19	Locked	
	demo2	2009/08/31 13:01:20	Locked	
	demo3	2009/08/31 13:01:21	Locked	
<input type="checkbox"/>	20191115_163209	2019/11/15 16:32:47	Executed	
<input type="checkbox"/>	20191115_163153	2019/11/15 16:32:01	Executed	
<input type="checkbox"/>	20191115_153811	2019/11/15 15:39:25	Executed	
<input type="checkbox"/>	20090831_131608	2019/11/15 15:38:11	Executed	
<input type="checkbox"/>	20191115_142802	2019/11/15 14:28:45	Executed	
Selected : 0 Protocols				
Delete		Export		

Unfold state

Protocol edit state

Fig 7

When the protocol list is in unfold state, users can do below operations:

- Search: Enter keyword to carry out searching automatically.
- Sorting: Protocols can be sorted according to “Name”, “Date” and “State”. “demo1”, “demo2” and “demo3” are always line on the first three position.
- Import: Importing protocols from U disk to instrument.
- Rename: For protocol name changing.
- Save as: Save as a new protocol.
- Edit: “Edit” button is locate on the top right corner, see Fig 7 unfold state.
- Account: Protocols of other accounts can be checked, but this function is only available for Admin account.

When protocol list in edit state, below operations are available:

- Sorting: Protocols can be sorted according to “Name”, “Date” and “State”.

- Checkbox: “” can be chosen for more than one for batch operation.
- Delete: Delete selected protocols.
- Export: For exporting selected protocols to U-disk.
- Cancel: Return to the unfold state of protocol list.

## 4. Read a Microplate

After protocol created, the next step is parameter settings according to experiment requirements.

### 4.1 Plate layout setting

The interface will move to layout interface automatically after finishing create a new protocol.

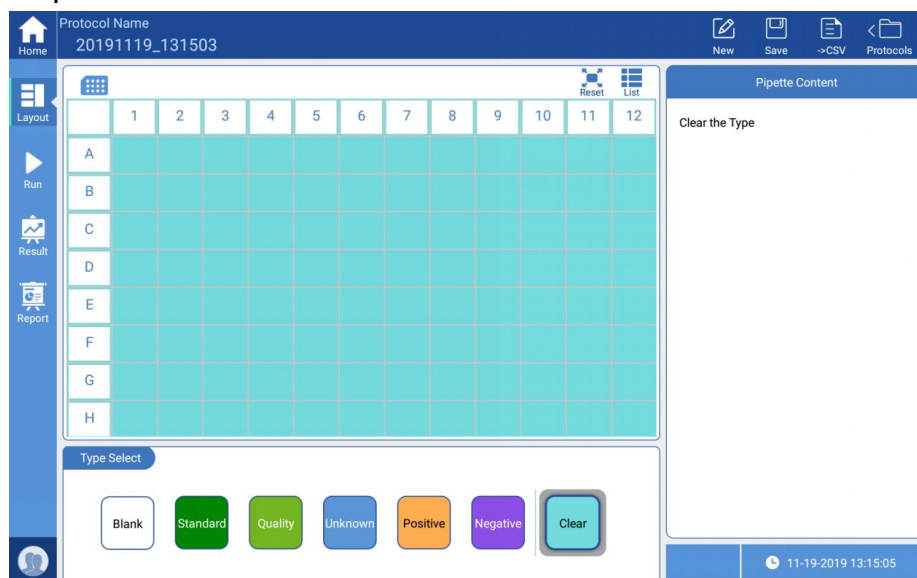
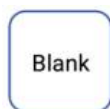

Fig 8

Meanwhile, the switching bar will turn out to be type select which includes 6 sample types, as well as clear option. Choose the right sample type, the optional bar will change accordingly, then click corresponding wells of the main display area to finish the settings.

**Note: the whole plate can be set if clicking the blank area on top left corner of the main display area.**



With white color on the interface, it is as blank control during running measurement. All blanks are duplicate wells in a same group.

Standard sample well which is used for creating standard curve, it is with green color. The optional bar will changed after clicking "Standard", see Fig 9.

- Replicates: Switch it on when setting the same standard for multiple wells.
- Concentrations: After setting the concentration and unit of the first well, the protocol will finish subsequent standard samples automatically according to the set operator and step size, also users can modify by manual by clicking corresponding wells.



Eg.: If the set concentration is 125ng/μL, the operator is "x" and the step size is "2", the concentration of the first well should be 125ng/μL, the second well 250ng/μL and the third 500ng/μL, etc.

- Sample groups: One sample group can have one standard curve.



For quality control during tests, it is with light green. It includes replicates and sample group, settings are the same as wells of standard samples.



With blue color, users can set several wells as unknown well, besides replicates and sample group, it has another option "Factor" for the dilution times of the solution, so as to get the concentration of the solution directly.

1: X means a solution was diluted by X times.



With orange color, users can set several wells as positive, as well as sample groups.

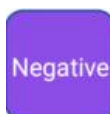

With purple, also several wells can be set as negative, and sample groups as well.



For clearing sample well settings.



Fig 9

**Note:** Elisa plate layout can be carried out before or after testing, for example, users can set all wells as “unknown”, do absorbance test, then layout of plate. The test data and layout are separated, users can modify or analyze the layout of historical data in real time.

**Remark:** The absorbance value of the test can not be changed!

### 4.2 Parameter setting

After finishing the Elisa plate layout settings, click “Run” on the side bar to Fig 10.

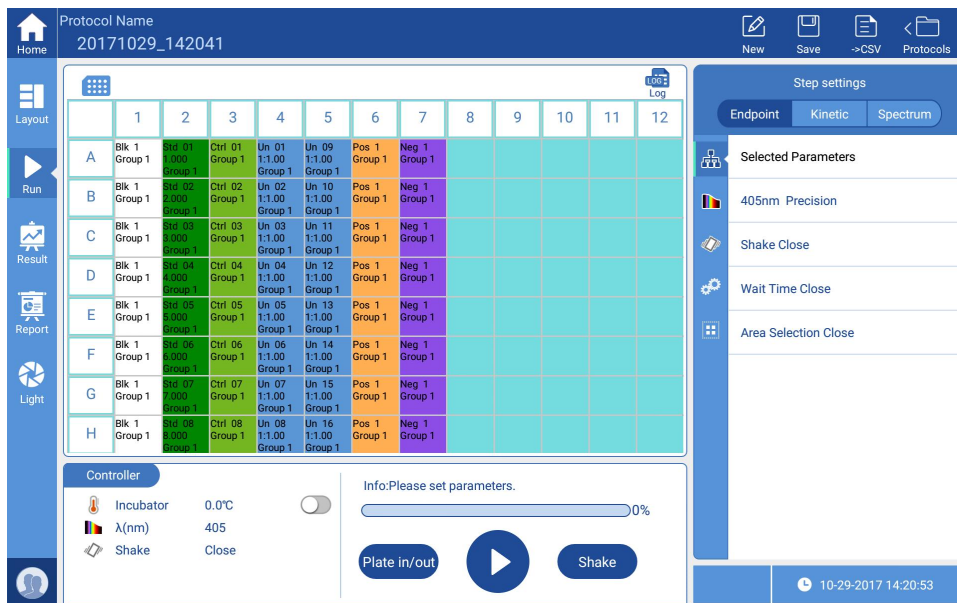

Fig 10

Meanwhile the switching bar will turn out to be controller which mainly includes below functions:

- Incubator: This function can make the plate detection chamber up to specified temperature, the temperature displays is the real time temperature.
- Wavelength: Shows wavelength parameters of the current protocol.
- Shake: This function can be on or off.
- Progress bar: Displays the running status of the current protocol.
- Plate in/out: Control the plate holder in and out, also there is Physical button on the front of the enclosure.
- Start/Stop: Also Physical button on the front of the enclosure.
- Shake: This button is independent from the shaking function in settings, and specially used for plate defoaming.

Meanwhile, the optional bar turns out to be step settings which separated into three settings according to different specific measurement method: Endpoint, Kinetic and Spectrum, for more details see below table 2.

**Table 2**

Endpoint	Kinetic	Spectrum
└ Selected Parameters	└ Selected Parameters	└ Selected Parameters
└ Wavelength	└ Wavelength	└ Wavelength
└ Mode	└ Mode	└ Mode
└ Fast	└ Fast	└ Fast
└ Precision	└ Precision	└ Precision
└ Wavelength	└ Wavelength	└ Wavelength
└ $\lambda_1$ (405)	└ $\lambda_1$ (405)	└ Start Wavelength
└ $\lambda_2$ (450)	└ $\lambda_2$ (450)	└ End Wavelength
└ $\lambda_3$ (492)	└ $\lambda_3$ (492)	└ Step
└ $\lambda_4$ (630)	└ $\lambda_4$ (630)	
	└ Kinetic	
	└ Total Time	
	└ Total Time	
	└ Kinetic region	
	└ No. of readings	
	└ Number	
	└ Kinetic region	

<ul style="list-style-type: none"> <li>└ Shake <ul style="list-style-type: none"> <li>└ Speed <ul style="list-style-type: none"> <li>└ Low</li> <li>└ Medium</li> <li>└ High</li> </ul> </li> <li>└ Type <ul style="list-style-type: none"> <li>└ Continuous</li> <li>└ Pulsed</li> </ul> </li> <li>└ Time</li> </ul> </li> <li>└ Wait Time at start</li> <li>└ Area Selection</li> </ul>	<ul style="list-style-type: none"> <li>└ Shake <ul style="list-style-type: none"> <li>└ Speed <ul style="list-style-type: none"> <li>└ Low</li> <li>└ Medium</li> <li>└ High</li> </ul> </li> <li>└ Type <ul style="list-style-type: none"> <li>└ Continuous</li> <li>└ Pulsed</li> </ul> </li> <li>└ Time</li> </ul> </li> <li>└ Wait Time at start</li> <li>└ Area Selection</li> </ul>	<ul style="list-style-type: none"> <li>└ Shake <ul style="list-style-type: none"> <li>└ Speed <ul style="list-style-type: none"> <li>└ Low</li> <li>└ Medium</li> <li>└ High</li> </ul> </li> <li>└ Type <ul style="list-style-type: none"> <li>└ Continuous</li> <li>└ Pulsed</li> </ul> </li> <li>└ Time</li> </ul> </li> <li>└ Wait Time at start</li> <li>└ Area Selection</li> </ul>
---	---	---

About wavelength option, Endpoint and Kinetic configured with four wavelengths(defaults are 405nm, 450nm, 492nm and 630nm), users can click modify wavelength by manual, but the value must be within the range 200nm~1000nm. Spectral analysis can accept wavelength of any band, but also should be within 200nm~1000nm.

In addition, there is a button named “Log” on top right corner of the main display area, the button is only available after the current protocol been executed.

The “Log” is mainly used for recording the finishing time of each step of the protocol.

**Note: Steps can not be edited if a protocol been executed, users can save it as a new one and then edit.**

### 4.3 Detect a Elisa plate

Click “” on screen or “Plate in/out” on the front of the enclosure, place an Elisa plate on the plate holder, attention to the direction please, see Fig 11.





Fig 11

Click button “▶” on screen or pressing “Start” button on the enclosure. If the protocol has been implemented, a hint will pop out for re-naming the protocol, input a new name, click “ok” to run the protocol, meanwhile, the plate holder will move into the Reader for sample detection, the screen will turn dark as Fig 12 and all buttons will unavailable except stop button “◻”, or users can press “Stop” button on the enclosure.

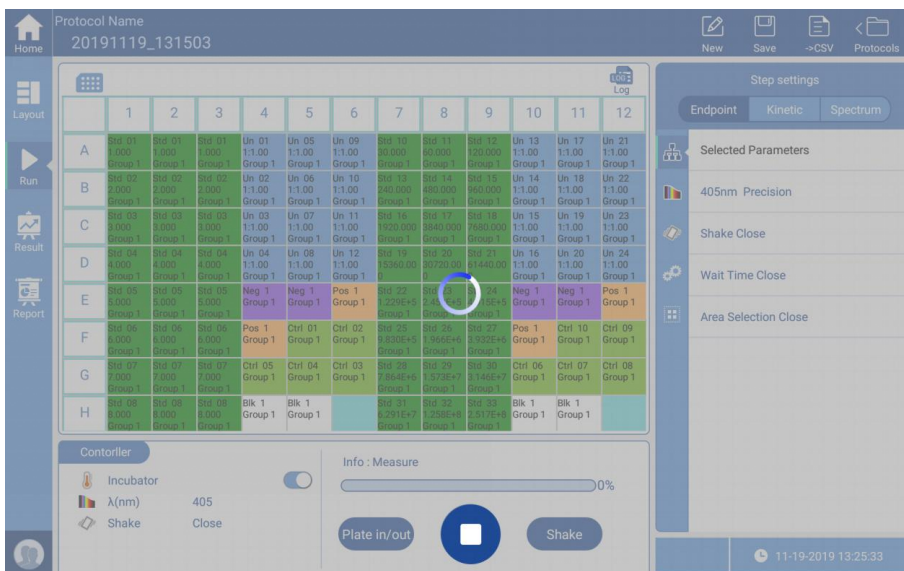

Fig 12

### 5. Result processing

The interface will stay in “Run” interface after detecting samples in “Run” interface and displays the original absorbance measured under the current

protocol. If users want results been analyzed, just switch to “Result” interface in the side bar, see Fig 13.

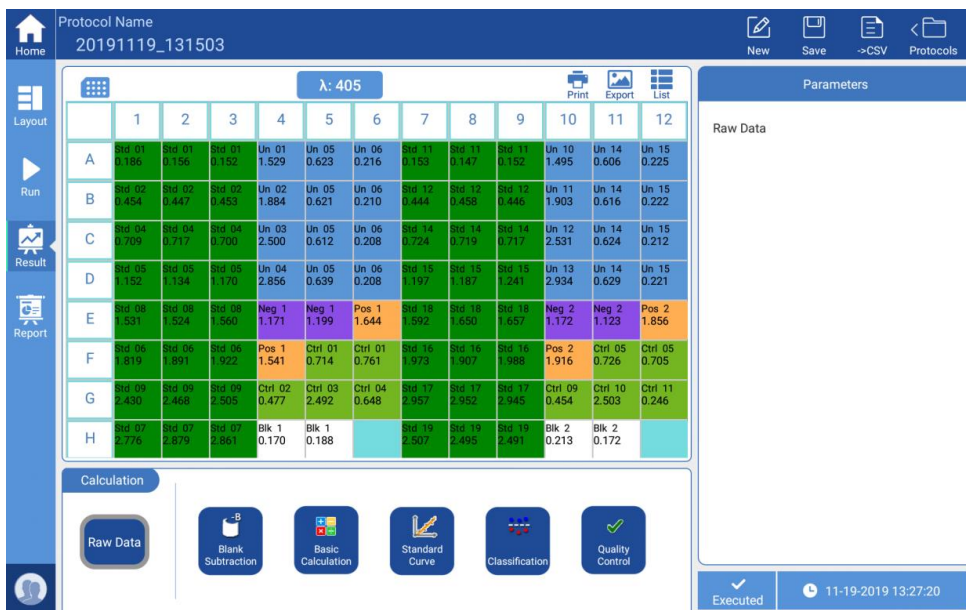

Fig 13

Result displayed different according to different layout of protocol settings and detection modes, the above Fig 13 is results of endpoint. Here, according to different types of detection modes, the Result is divided into three modes: Endpoint, Kinetic and Spectrum.

### 5.1 Endpoint result

As Fig 13 shows, data processing type of endpoint result includes “Raw Data”, “Blank Subtraction”, “Basic Calculation”, “Standard Curve”, “Classification” and “Quality Control”.

- Raw data: Displays absorbance values of each well, users can switch different wavelengths by pressing the button “λ: 562” in the middle upper of the main interface.
- Blank Subtraction: Blank absorbance is obtained according to blank samples, then subtract the blank absorbance for each well.

**Note: 1. Protocol layout interface must have blank well, otherwise the button is not available.**

**2. If a protocol is set with blank sample, the absorbance values of “Basic Calculation”, “Standard Curve”, “Classification”, “Quality Control” and “Kinetic Analysis” are all values subtracted blank.**

- Basic Calculation: The four basic arithmetics “+”, “-”, “x”, “/” can be



performed for the absorbance at different wavelengths of the same well.

- Standard Curve: Based on the concentration of the standard well and measured absorbance, the instrument will generate corresponding standard curve according to standard sample sequence for sample concentration calculation, see Fig 14. If there are several groups of standard curves, users can click “Group:1” button to switch to other standard curves.

**Note: The fitting type must be same when several groups of standard curves, or users can not export them together, only can export one by one.**



Fig 14

If the fitting is not that good, users can modify the fitting type from “Parameters” on the right of the interface, or perform curve fitting after preprocessing the measured absorbance value and the input standard sample concentration value for a better result. Below 8 fitting types are available:

- Linear fitting
- 4 parameters
- Quadratic polynomial
- Cubic polynomial
- Quartic polynomial
- Point-to-point
- Cubic Spline

➤ Logit/Log

The absorbance value and concentration value of standard sample can be pretreated by concentration conversion and absorbance conversion, this instrument supports four types as below:

- Linear/Linear (Linear fitting of absorbance value and corresponding concentration)
- Linear/Log (Linear fitting of absorbance value and the logarithm of the concentration)
- Log/Linear
- Log/Log

**Note: Protocol layout interface must have standard well, different fitting algorithm needs different quantity of standard samples, please check the layout settings when curve fitting failure.**

- Classification: According to the negative and positive reference set in the layout interface, samples can be qualitative analyzed, as shown in Fig 15, input corresponding formula on the right side of the interface, the instrument will mark negative or positive sample wells automatically, positive is marked with “+”, low positive is with “+ ”, negative is without any mark.



Fig 15

**Note: Protocol layout interface must have positive or negative well, or the button is not available.**

- Quality Control: Click “Quality Control” button, the interface will turn to Fig 16, the main display area will turn out to be a list, it displays status of the quality control well which set previously, instrument will mark according to conditions set in “Parameters”.

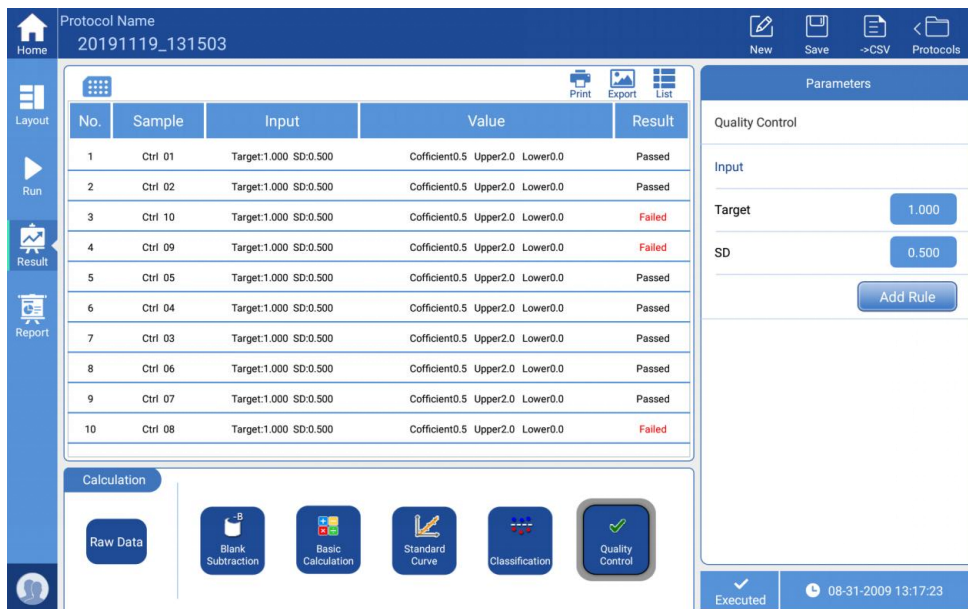

Fig 16

**Note: Protocol layout interface must be set with “Quality” well, otherwise, this button will be not available.**

### 5.2 Kinetics

As Fig 17 shows, the main display area is not absorbance values, but kinetic curves.



Fig 17

Choose the target well, click “Graph” button can enlarge the kinetic curve, see Fig 18, then click “Back” to graph main interface.



Fig 18

“Calculation” area turns out four types: “Raw Data”, “Blank Subtraction”, “Basic Calculation” and “Kinetic Analysis” as the above Fig 18 shows.

For functions and algorithms of “Raw Data”, “Blank Subtraction” and “Basic Calculation”, please see section 5.1.

Click “Kinetic Analysis” button, the optional bar on the right side will change, see Fig 19.

At present, it includes below calculations:

- Average/SD/CV%: Calculate the average, standard deviation and CV % of the set reading value
- Integral: Calculate the integral area of the kinetic curve,
- Baseline Subtraction: Select a baseline, all reading value minus the corresponding baseline values.
- Select Single Reading: Read a single point value.
- Select Reading Range: Set range of reading, read each wavelength of Kinetic test data.
- Maximum Rate: In the reading range, maximum rate of the kinetic curve.
- Maximum (Peak): In the reading range, maximum of the kinetic curve.

**Note: According to different types of calculation, parameter selection and the content of the main display area will change according to the chosen type.**

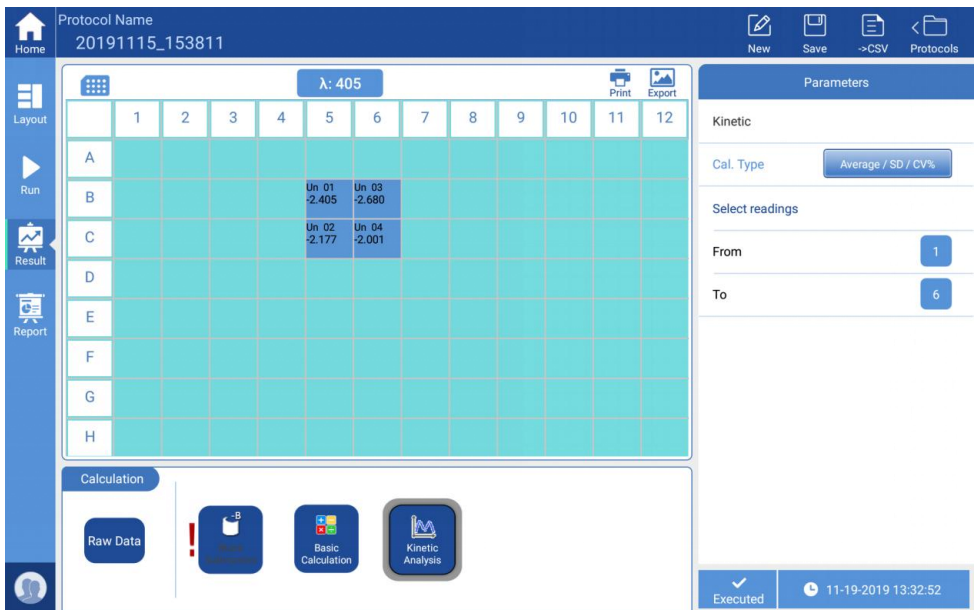

Fig 19

### 5.3 Spectral Analysis

See Fig 20, select target wells, click “Graph” button to enlarge the spectral curve, the absorbance of each wavelength shown on the curve. Users can click “Back” button to the graphic main interface.

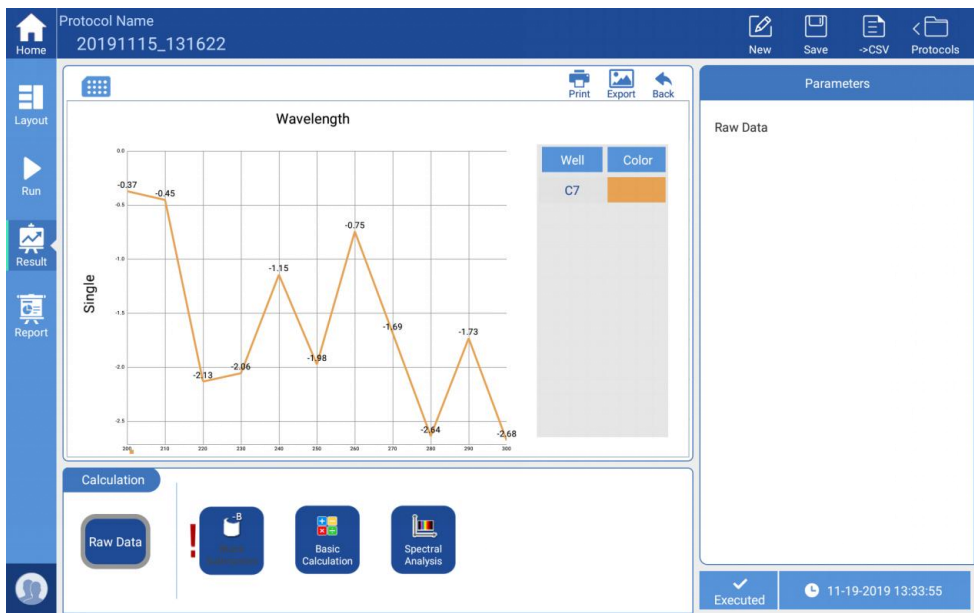

Fig 20

Click “Spectral Analysis”, view Fig 21.

Calculation types includes:

- Spectral Maximum: Read the maximum value greater than the threshold value within a set range.
- Spectral Normalization: Set the spectral range, take the maximum

absorption peak as 1, the remaining values will be converted into percentage based on this criterion.

- Ration within Spectrum: Set two wavelength values  $\lambda_1$  and  $\lambda_2$ , calculate the value of  $\lambda_1/\lambda_2$ .
- Select Wavelength Range: Read measurement values within a set wavelength range.
- Select Single Wavelength: Read the measurement value of a single wavelength.

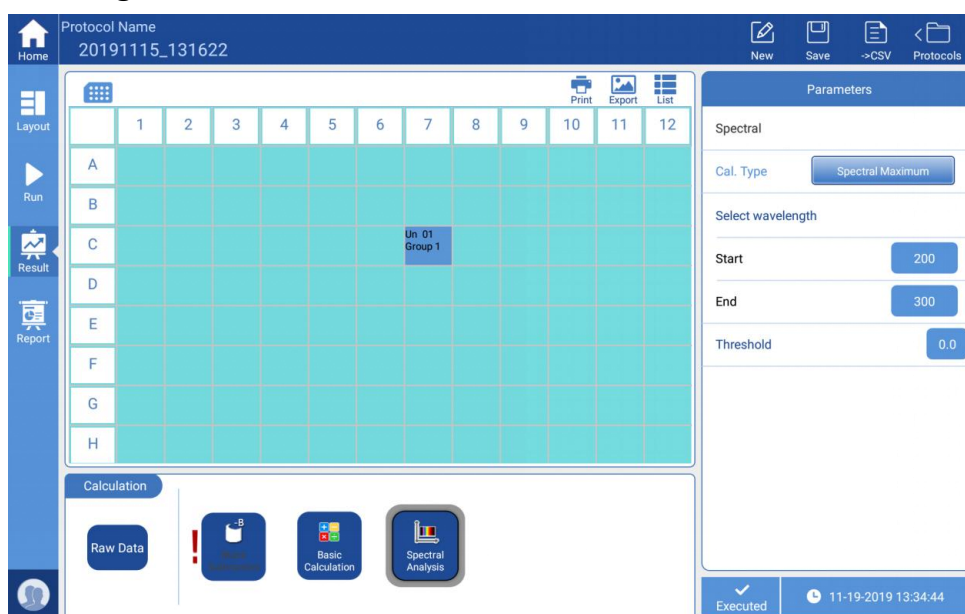







Fig 21

Description of each button on the upper right corner of the main display area:

-  Print Print the current content of the main display area.
-  Export Export the current content of the main display area in picture format to U-disk.
-  Graph Choose the well to view the kinetic curve, “Graph” button can enlarge the curve, see Fig 18, “Back” is for graphic main interface.
-  List Switch graphic display to data list display, click “Plate” button in the upper right corner to switch to graphic display.
-  Reset Restore the zoom function.
-  Back Back to previous interface.



## 6. Report exporting

Both processed data and raw data can be exported, click “Report” button on the left side to the main interface of reports, see Fig 22.

The screenshot shows the software interface for a microplate reader. At the top, the protocol name is '20191119\_131503'. The main area displays a data table with columns numbered 1-12 and rows labeled A-H. The table contains numerical values for various wells. Below the table, there is a 'File Type' section with icons for XLS, CSV, PDF, and TXT, along with a 'Print' button. On the right side, there is an 'Output Content' panel with a list of items to be included in the report, each with a checkmark: Info, General information, Instrument information, Protocol parameters, Layout definitions, RawData, Result, Blank Subtraction, and Basic Calculation. An 'Output' button is located at the bottom of this panel. The bottom status bar shows 'Executed' and the time '11-19-2019 13:36:11'.

	1	2	3	4	5	6	7	8	9	10	11	12
A	0.186	0.156	0.152	1.529	0.623	0.216	0.153	0.147	0.152	1.495	0.606	0.225
B	0.454	0.447	0.453	1.884	0.621	0.210	0.444	0.458	0.446	1.903	0.616	0.222
C	0.709	0.717	0.700	2.900	0.612	0.208	0.724	0.719	0.717	2.531	0.624	0.212
D	1.152	1.134	1.170	2.856	0.639	0.208	1.197	1.187	1.241	2.934	0.629	0.221
E	1.531	1.524	1.560	1.171	1.199	1.644	1.592	1.650	1.657	1.172	1.123	1.856
F	1.819	1.891	1.922	1.541	0.714	0.761	1.973	1.907	1.988	1.916	0.726	0.705
G	2.430	2.468	2.505	0.477	2.492	0.648	2.957	2.952	2.945	0.454	2.503	0.246
H	2.776	2.879	2.861	0.170	0.188		2.507	2.495	2.491	0.213	0.172	

Fig 22

Choose the right format on “File Type” area, four formats are available:

- Xls
- Csv
- Pdf
- Txt

Choose the content to export in “Output Content” on the right side, “v” will appear, then click “Output” to export data to U-disk.

“Print”: Due to too much of data, print function is only for instrument basic information, including instrument serial number, software version etc.

## 7. Power off

Remove ELISA plate from the Reader, then plate in the plate holder to the chamber.

Turn off the power switch on the back of the instrument.

## Chapter 6 Cuvette function description

### 1. Interface function

Click the Cuvette icon to enter the cuvette function interface, as Fig 23. This interface mainly composed by five parts: the navigation bar at the top, the sidebar, the main display area, the optional bar, switching bar.

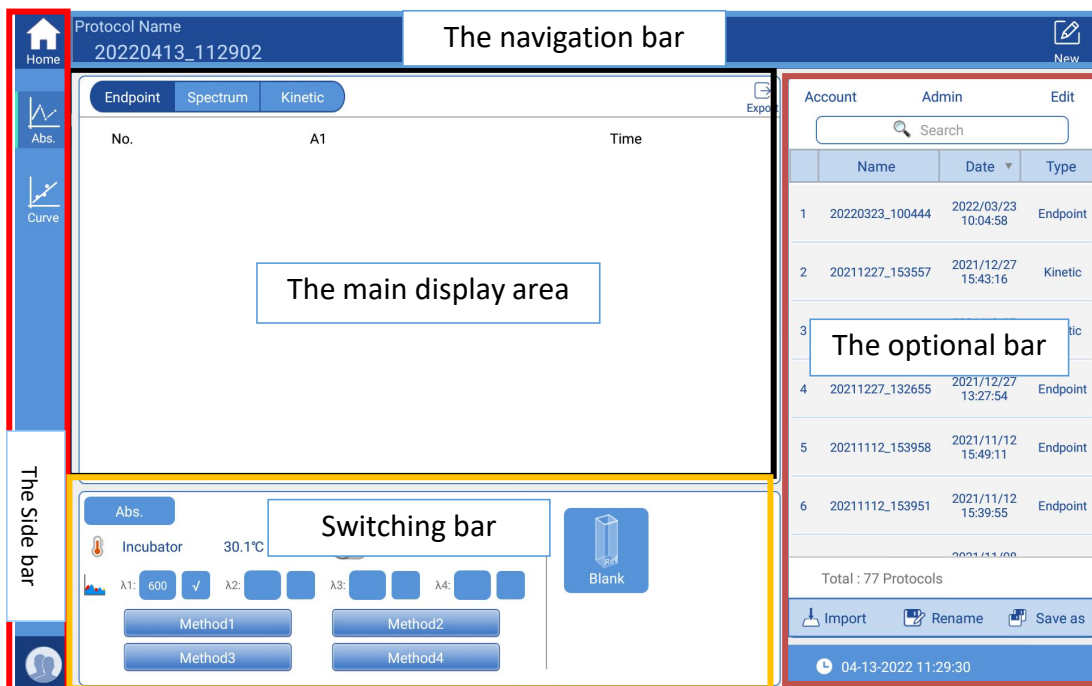



Fig 23

Function keys of protocol management are almost in the navigation bar, it can complete new operations, such as table 6-1.

Table 6-1

Icon	Function
Protocol Name 20220413_112902	Protocol name can be modified by clicking it directly before reading.
	New protocol. The default name of a new protocol is the system time, and it can be modified by manual. A hint will pop-up when a modified protocol not saved.

### 2. Abs-Endpoint

It can set the method before the program runs. Click Method 1/2/3/4, as figure below.



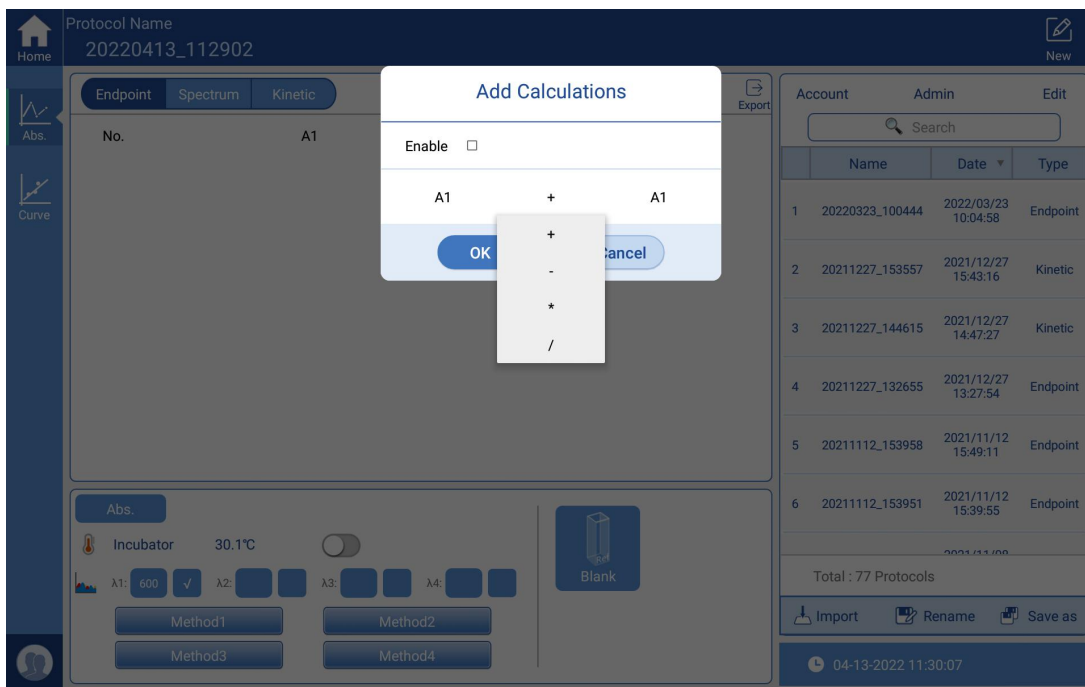

Fig 24

After running with Endpoint method, the interface as shown in figure below, the calculations area is gray, and will not be changed.

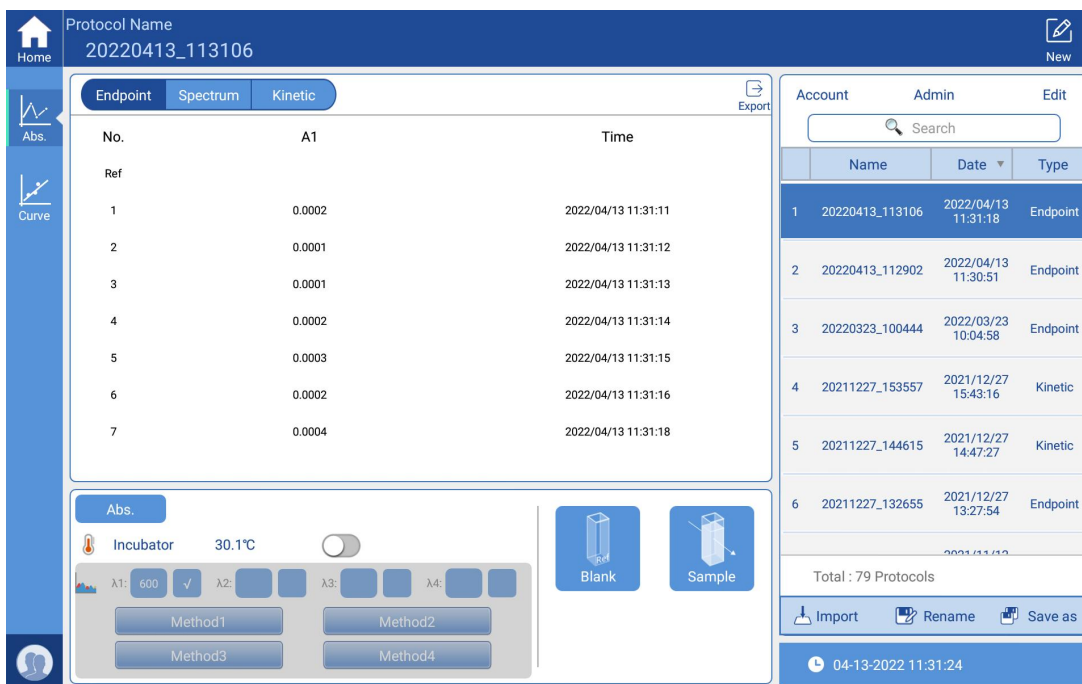









Fig 25

The function of Endpoint interface as table 6-2.

**Table 6-2**

Icon	Function
	At upper left corner, select type of protocol: Endpoint, Spectrum, Kinetic.
	New protocol. The default name of a new protocol is the system time, and it can be modified by manual. A hint will pop-up when a modified protocol not saved.
	Export the content in the main display area to U disk.
The main display area	Display the result of reading and calculation according to the wavelength which is set by user.
 Incubator	Incubation function, off by default, the user can set incubation temperature, the highest can be set up to 45 °C.
	Wavelength can be input, and confirm whether to open it.
	A total of four method, the user can set the method.
	Click for blank testing.
	Click for sample testing.

### 3. Abs-Spectrum

Click “Spectrum”, enter Spectrum interface, as figure below. It can set the

parameter for spectrum testing now.

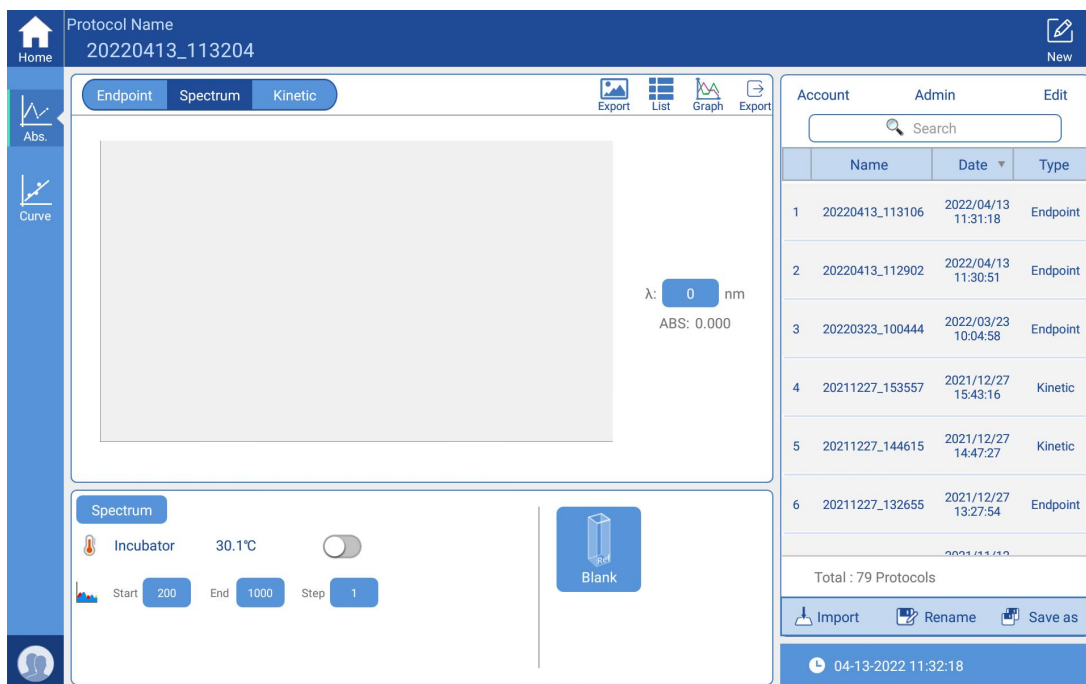

Fig 26

The function of spectrum interface as table 6-3.

Table 6-3

Icon	Function
Start	Users can set the initial wavelength of the detection range, wavelength range 200-1000.
End	Users can set the end wavelength of the detection range, wavelength range 200-1000.
Step	Users can set step values.
	Spectral scanning data is exported as a picture.
	Detection data is displayed as a list.
	Detection data is displayed as a graph.

Displayed as a list

No.	Wavelength	Absorbance
1	400	-0.0001
2	401	0.0001
3	402	-0.0001
4	403	-0.0001
5	404	0.0000
6	405	0.0000
7	406	0.0000
8	407	0.0001
9	408	0.0000
10	409	0.0001

Number
Ref
1

OK

Fig 27

Displayed as a graph

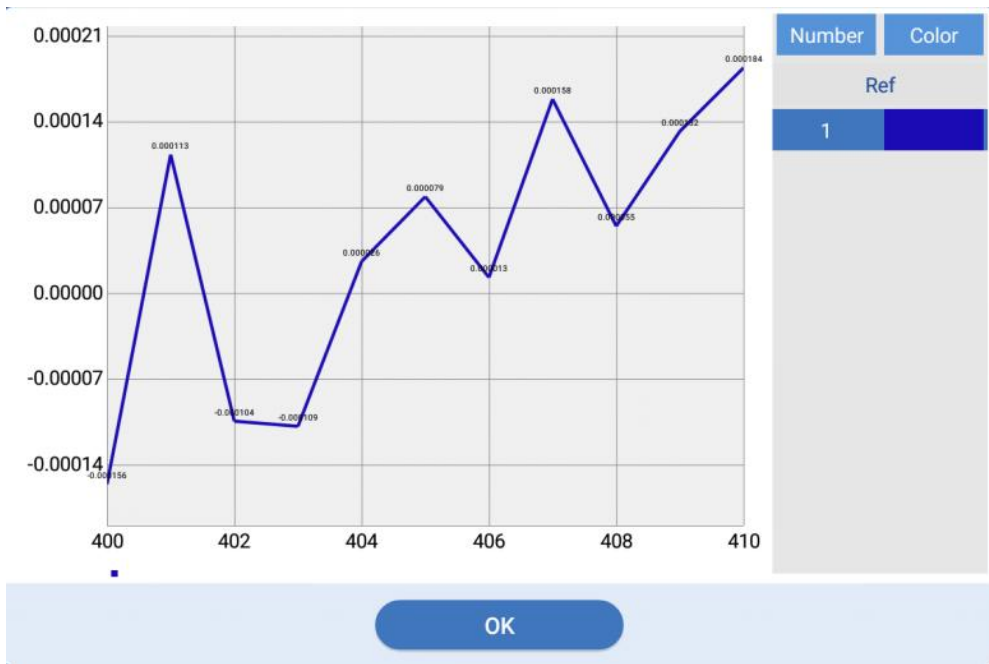

Fig 28

After protocol complete running, on the left side of the display area is the reading curve, display the results for the corresponding data of headline in list. If it need check a certain wavelength absorbance value, there is a icon

“ λ: 0 nm ” on the right of display area for checking, as figure below.

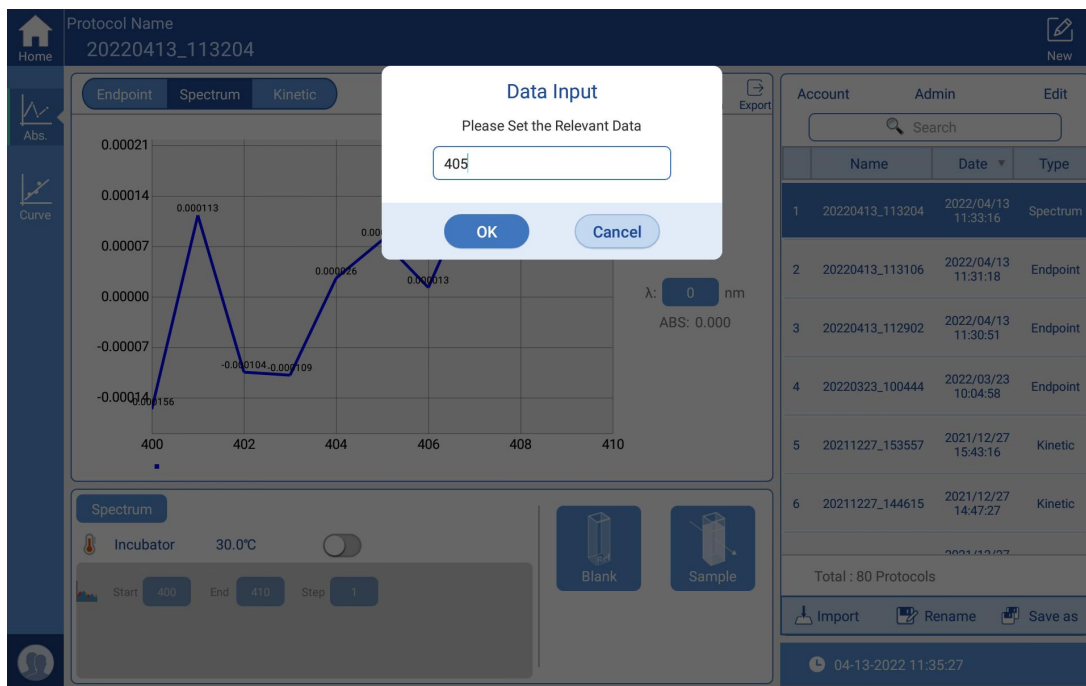

Fig 29

### 4. Abs-Kinetic

Click “Kinetic”, enter Kinetic interface, as below figure. It can set the parameter for Kinetic now.

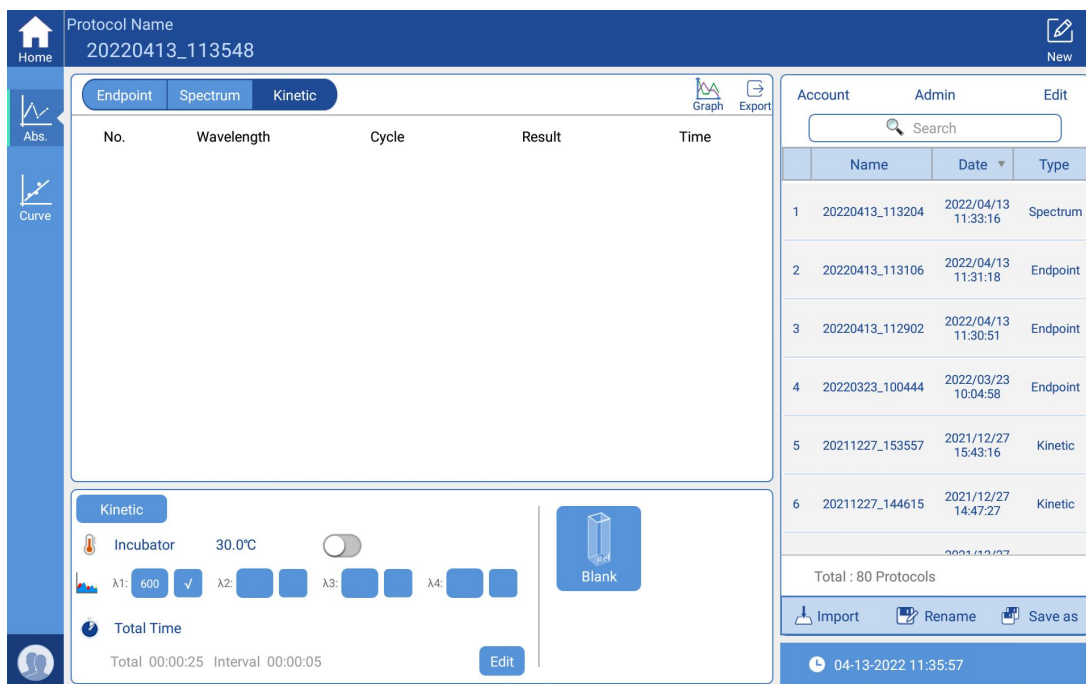

Fig 30

In switching bar at bottom, wavelength  $\lambda$ : Input wavelength for reading; Click edit to set time and numbers for kinetic testing, as figures below. Total time: Total running time, up to 99:59:59. Number of readings: Input number for kinetic, range is 2~99, internal time can be set freely, range is 99:59:59.

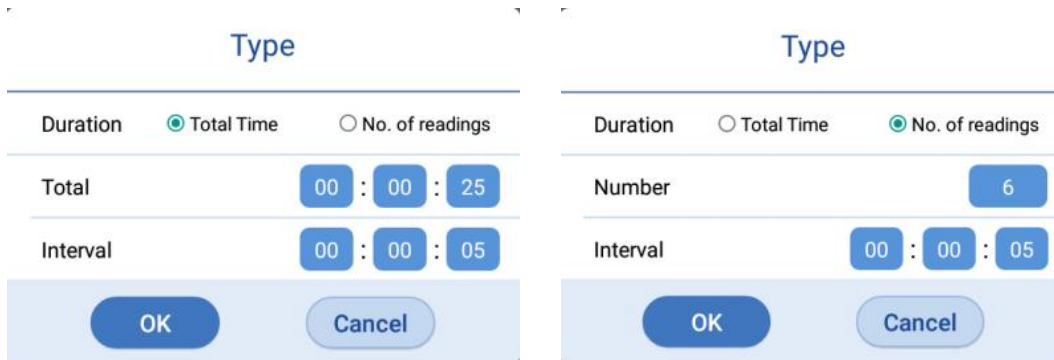

Fig 31

After protocol complete running, display area show data list.  $\lambda$  and total time is not available, as figure 32. If it need check the graph of reading data, click graph at top right corner, as figure 33.

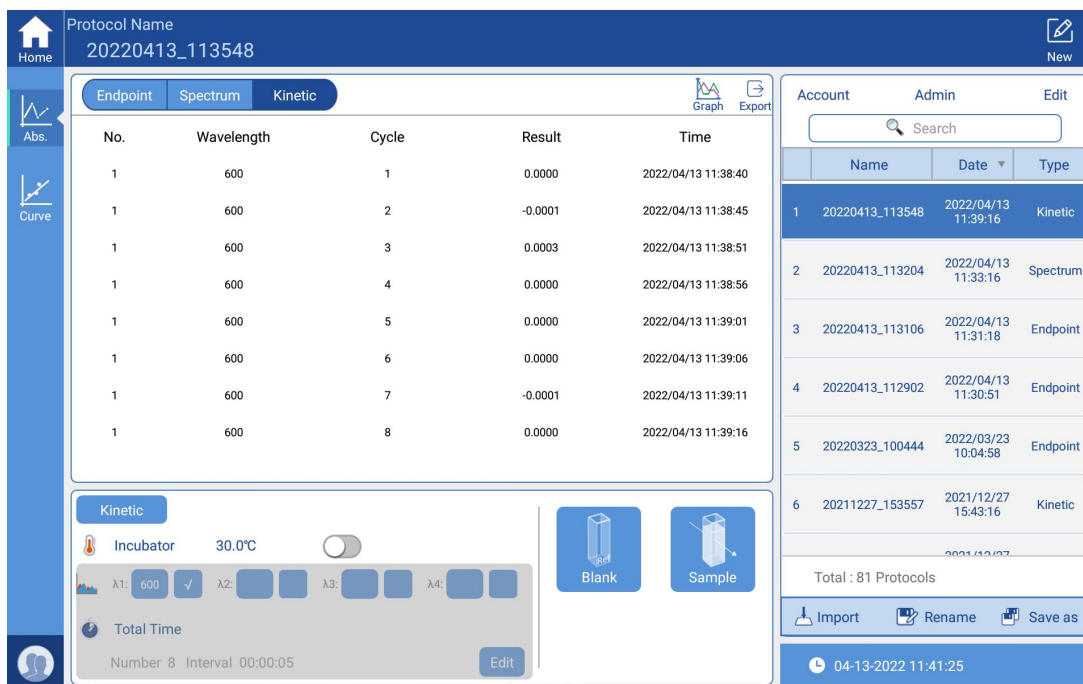

Fig 32

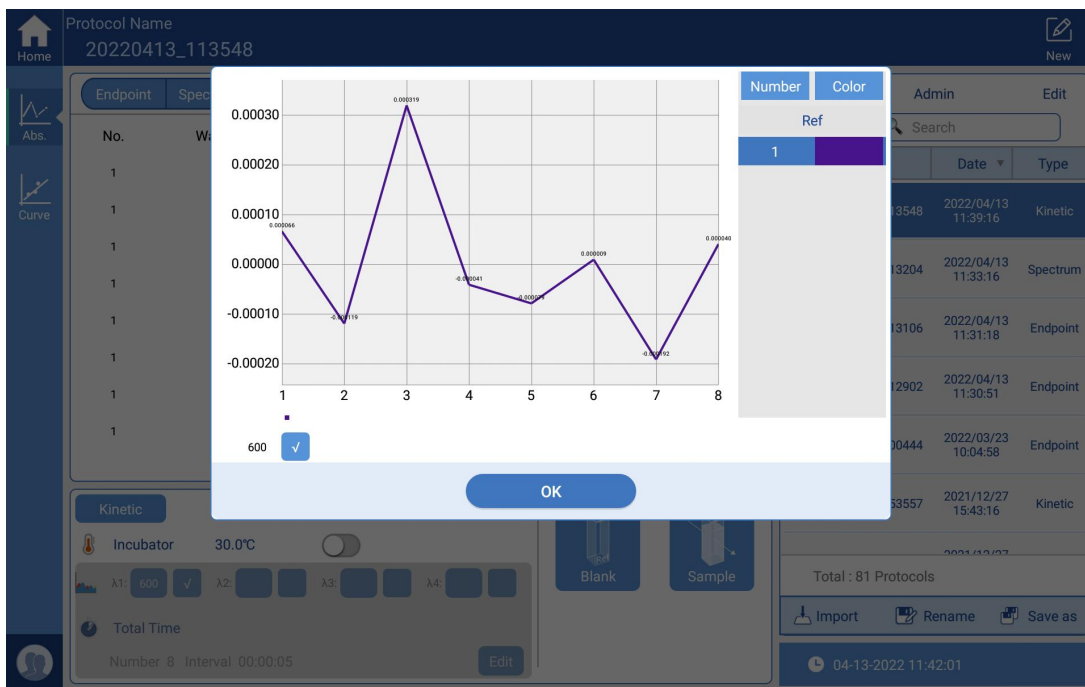

Fig 33

### 5. Standard Curve——Curve

Click “Curve”, enter Standard Curve interface, as figure below. It can set the parameter for standard curve now.

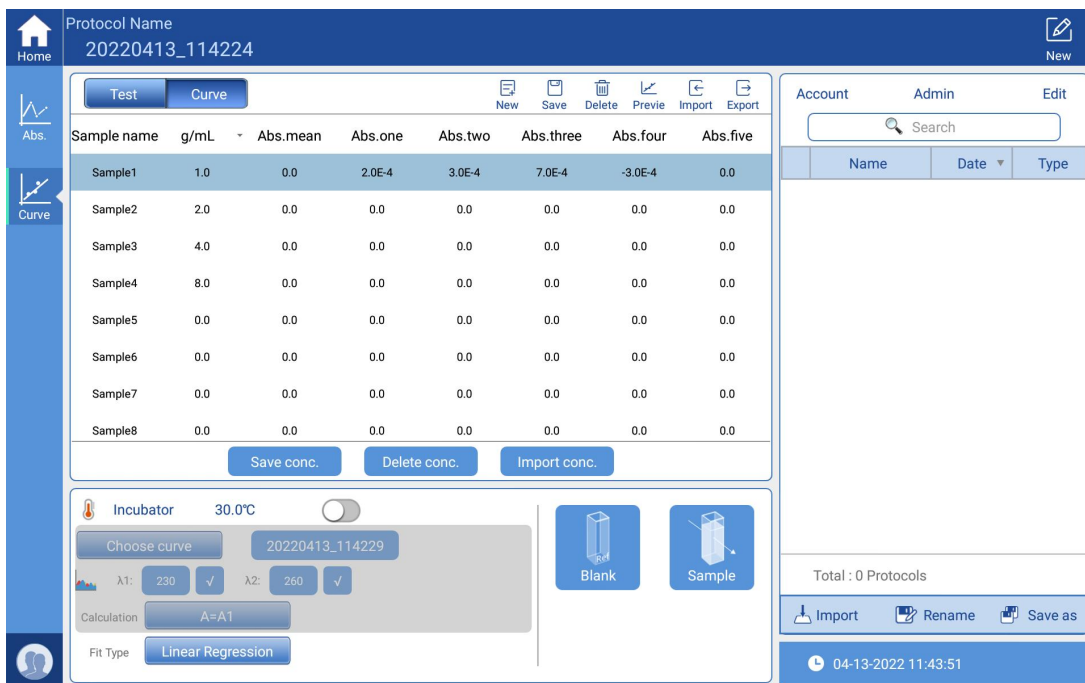















Fig 34

Function of standard curve interface, as table 6-4.

Table 6-4

Icon	Function
	Click to select a test or curve.
	Create a new standard curve.
	Click the icon to save the current standard curve, unable to modify after saving.
	Click the icon to pop up the prompt box to ask if to delete the current standard curve.
	Click the icon to pop up the standard curve preview interface.
	Click import, judge if there is a U disk, if no, will give tip; If yes, read the default path under the folder and indicate the standard curve list.
	Export the current standard curve to the U-Disk.
	Save the set concentration.
	Click and the prompt box will pop up to ask if to delete the concentration of the setting
	Click import, judge if there is a U disk, if no, will give tip; If yes, read the default path under the folder and indicate the concentration file list.
	Select the standard curve to fit.
	Input wavelength value.
	Set the calculation method.
	Select the fit type.



Calculation type and Fit type as Fig 35.



Fig 35

## 6. Standard Curve——Test

Click “Curve” in side bar, enter standard curve interface, as below figure. It can set the parameter for standard curve now.

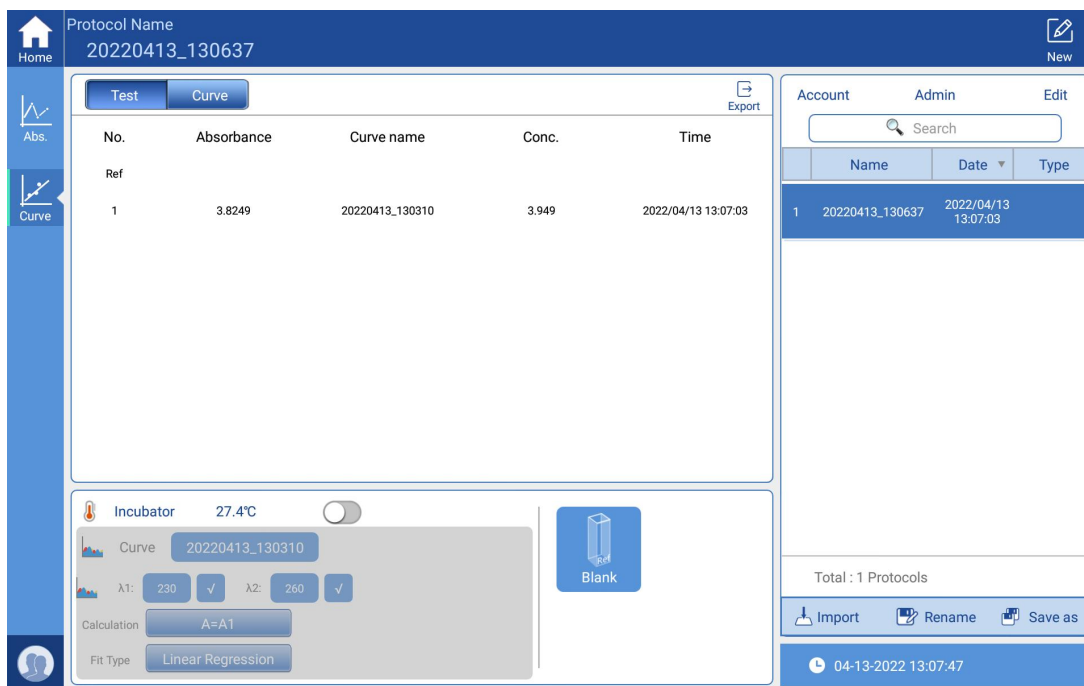

Fig 36

Curve at bottom switching bar: It can select an existing standard curve to calculate. After protocol complete running, display area show data list.

## Chapter 7 Maintenance, storage, transportation

### 1. Maintenance

- Keep storage environment dry and clean to prevent moisture, corrosion, away from strong electromagnetic interference sources.
- Instrument already calibrated before leave factory. User is not allowed to disassembly and make adjustment. Any defectiveness, please contact manufacturer.
- Continuous emergency turning on/off is not allowed.
- Make sure apply the device with correct input voltage scope.
- Maintenance list

Content	/Day	/Week	/Year	When needed
Make sure the instrument power off correctly.				√
Keep the instrument away from dust	√			
Remove overflowing solution right away in case any damage, then clean it by deionized-distilled water.	√			
If the surface been contaminated with a biohazard, sterilize it by mild disinfectant.	√			
Clean instrument enclosure regularly.		√		
Clean the plate holder when necessary.		√		
Verification by using light absorption verification plate.			√	
Sterilize the instrument when re-installing or maintaining.			√	
Maintenance				√

### 2. Storage and transportation

- Storage at room temperature  $-10^{\circ}\text{C} \sim 45^{\circ}\text{C}$ , relative humidity less than 80%, without corrosive gas and with good ventilation.
- Keep away from heavy shock, vibration, and humidity during transportation.

## Chapter 8 Troubleshooting

No.	Trouble description	Possible reason	Solution
1	The Microplate Reader can not be started	Power supply failure	a. Check the if the instrument energized b. If the power plug loose c. Check the voltage.
2	“Communication timeout” during self-checking	Instrument not working	Restart the instrument and try again; if still same problem, please contact your distributor or manufacturer.
3	“E913, E923, E933, E943” during self-checking	Insufficient of light intensity	Please contact your distributor or manufacturer.
4	“E912, E922, E932, E942” when self-checking	Light intensity is too strong	Please contact your distributor or manufacturer.
5	“E911, E921, E931, E941” when self-checking	Excessive dark current	Please contact your distributor or manufacturer.
6	“E612, E622, E632, E642” when self-checking	Detection module failure	Please contact your distributor or manufacturer.
7	“E401, E403, E415, E425, E435, E445” when self-checking	Motor failure	Please contact your distributor or manufacturer.
8	“E011~E056” when self-checking	Incubation failure	Please contact your distributor or manufacturer.
9	Test results are greatly deviated or all are zero	Xenon lamp damaged	Restart the instrument and try again; if still same problem, please contact your distributor or manufacturer.
10	Elisa plate holder can not in or out	Blocked by something	Check whether obstacles around the plate holder or whether the plate cover is raised.
11	Crash noise occurred during running	The Elisa plate is not in place or plate cover fell off	a. Check Elisa plate b. If noise still there when running without plate, restart the instrument c. If noise still there, please contact your distributor or manufacturer.
12	Test results unstable	Light path failure	Check if the plate is placed well, if liquid spilled out and whether the front door works well, then re-start the instrument. If problem still there, contact your distributor or manufacturer.
13	Stop running during detection	Communication breakpoint	Press “stop”, restart the detection.

## Memo